



# The Automation Engineer in ENEL

**Giulio Davico**

*I&C, Voltage & Speed Regulation*

Rome, February 20, 2020



# Automation Engineer: where we “applied” in ENEL

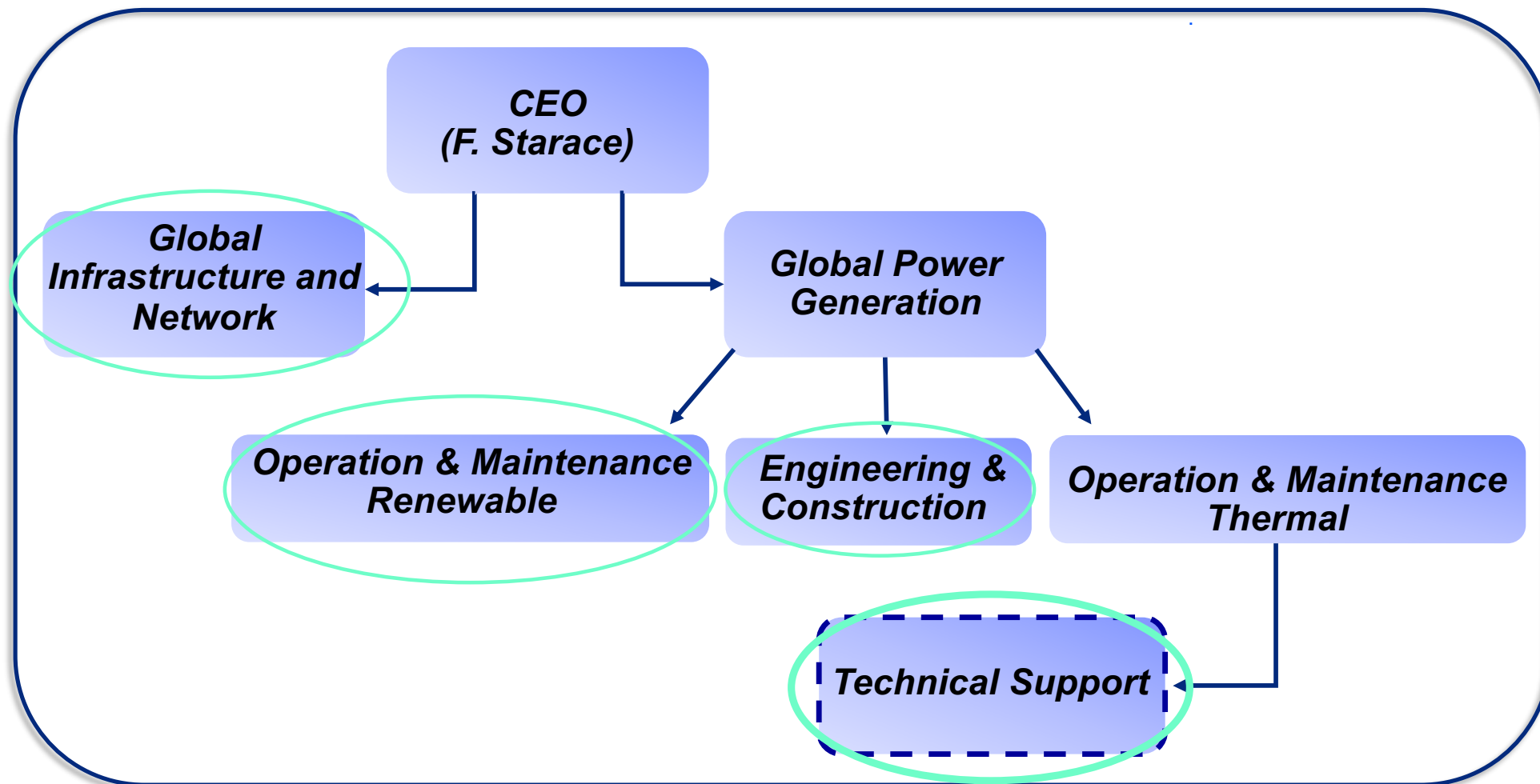

# Automation Engineer: the value of a cross competence figure



A lot, but different from what you expect (probably)



Thermal PP  
Hydro  
Renewables  
Distribution  
etc.



*Entire production units to be controlled*

*Machines to be controlled*

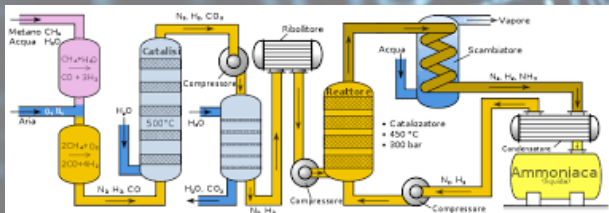

*Processes to be controlled*



# Technical Support dimension: challenges and opportunities

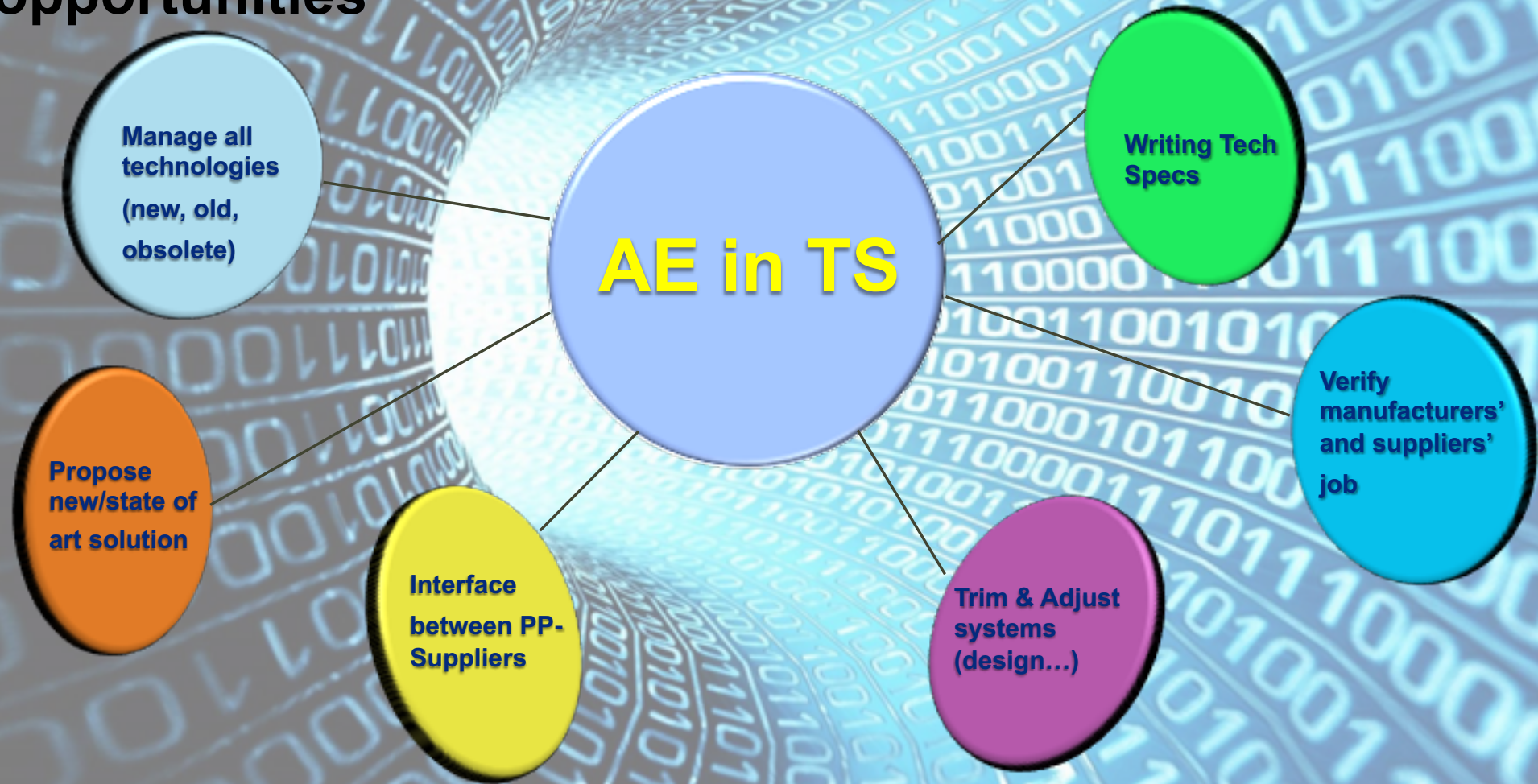

# Automation Engineer in TS: what's the job

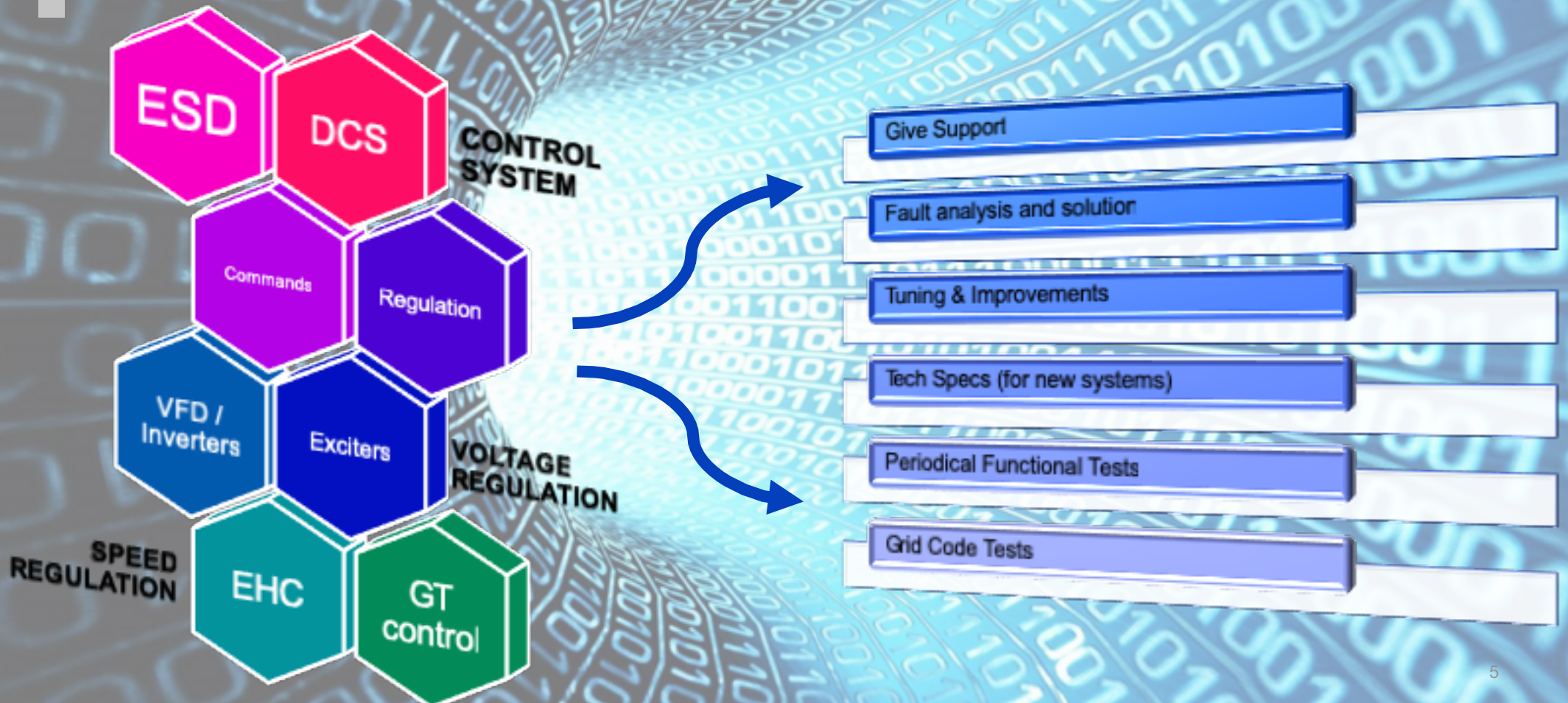

# Automation Engineer in a multidisciplinary environment

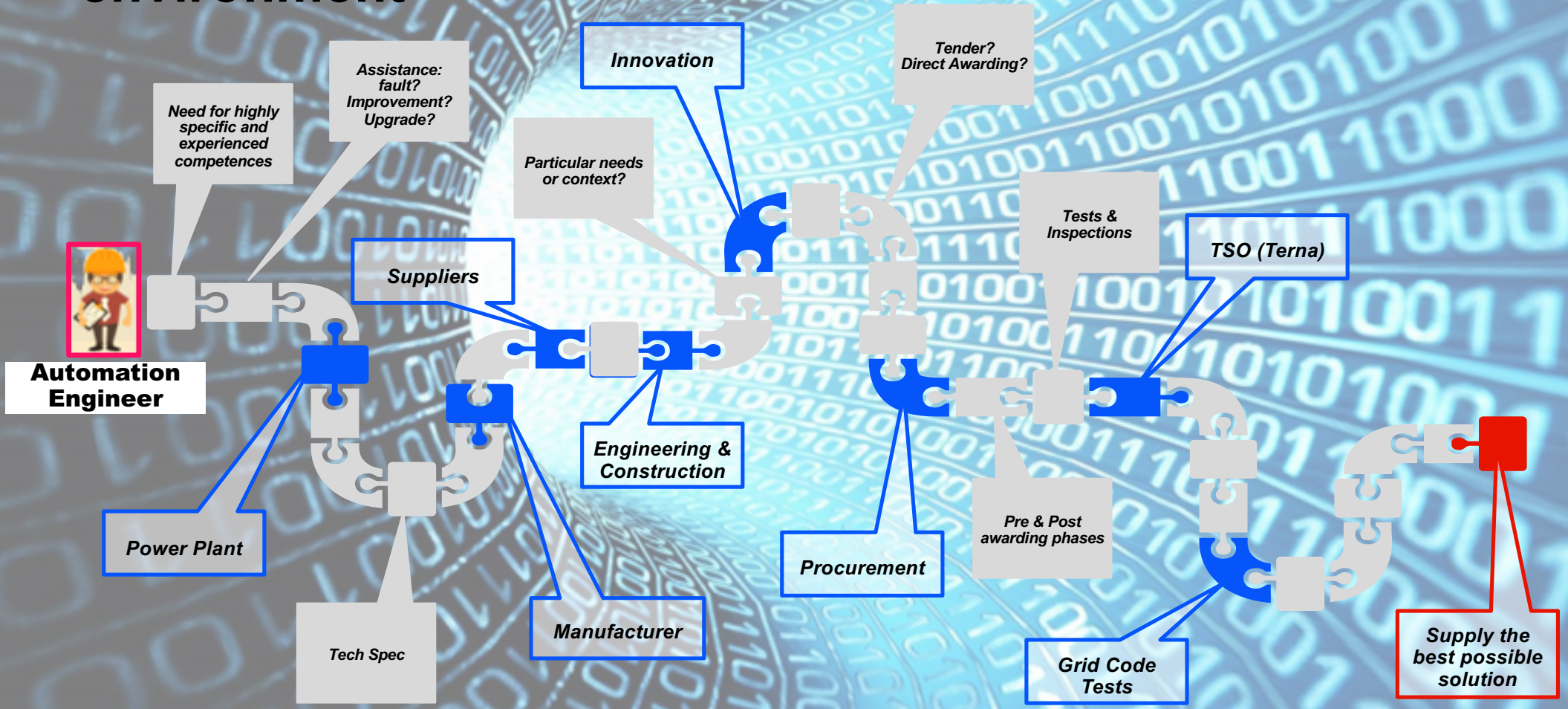

# Let's see some examples...

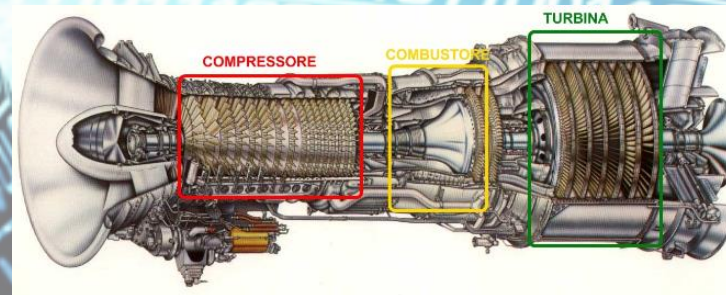
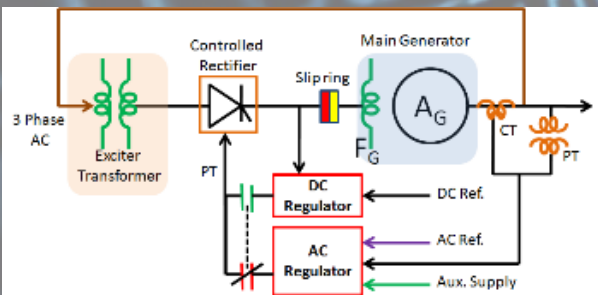
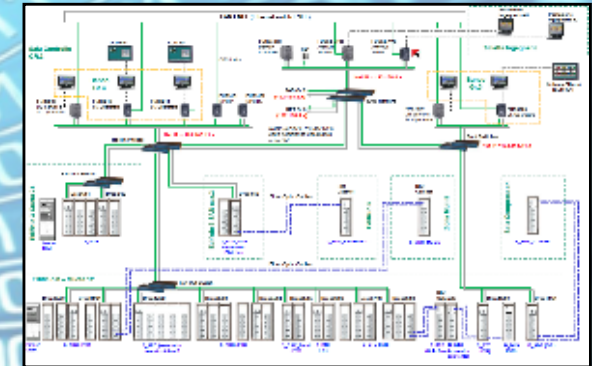

***Thanks for your attention***